

- **Ideal for 310.00 MHz Transmitters**
- **Very Low Insertion Loss**
- **Quartz Stability**
- **Ultra Miniature Ceramic SMD Package (QCC8C)**

SR5409

Absolute Maximum Rating (Ta=25°C)		
Parameter	Rating	Unit
CW RF Power Dissipation	P	0
DC Voltage	V_{DC}	±30
Operating Temperature Range	T_A	-10 ~ +60
Storage Temperature Range	T_{stg}	-40 ~ +85

Electronic Characteristics						
Parameter	Sym	Minimum	Typical	Maximum	Unit	
Frequency (25°C)	Nominal Frequency	f_c	NS	310.00	NS	MHz
	Tolerance from 310.00 MHz	Δf_c	-	-	± 75	KHz
Insertion Loss		IL	-	1.3	1.8	dB
Quality Factor	Unloaded Q-Value	Q_U	-	12,325	-	-
	50Ω Loaded Q-Value	Q_L	-	1,700	-	-
Temperature Stability	Turnover Temperature	T_o	25	-	55	°C
	Turnover Frequency	f_o	-	f_c	-	KHz
	Frequency Temperature Coefficient	FTC	-	0.032	-	ppm/°C ²
Frequency Aging	Absolute Value during the First Year	$ f_A $	-	-	10	ppm/yr
DC Insulation Resistance Between any Two Pins		-	1.0	-	-	MΩ
RF Equivalent RLC Model	Motional Resistance	R_M	-	16	23	Ω
	Motional Inductance	L_M	-	101.2944	-	μH
	Motional Capacitance	C_M	-	2.6048	-	fF
	Shunt Static Capacitance	C_o	2.6	2.9	3.2	pF

NS = Not Specified

Note:

- The frequency f_c is the frequency of minimum IL with the resonator in the specified test fixture in a 50Ω test system with VSWR ≤ 1.2:1.
- Unless noted otherwise, case temperature TC = +25°C±2°C.
- Frequency aging is the change in fC with time and is specified at +65°C or less. Aging may exceed the specification for prolonged temperatures above +65°C. Typically, aging is greatest the first year after manufacture, decreasing in subsequent years.
- Turnover temperature, T₀, is the temperature of maximum (or turnover) frequency, f₀. The nominal frequency at any case temperature, TC, may be calculated from: $f = f_o [1 - FTC (T_o - T_o)^2]$.
- This equivalent RLC model approximates resonator performance near the resonant frequency and is provided for reference only. The capacitance C₀ is the measured static (nonmotional) capacitance between input terminal and ground or output terminal and ground.
- The measurement includes case parasitic capacitance.
- Derived mathematically from one or more of the following directly measured parameters: f_c , IL, 3 dB bandwidth, f_c versus T_C, and C₀.
- The specifications of this device are based on the test circuit shown above and subject to change or obsolescence without notice.
- Typically, equipment utilizing this device requires emissions testing and government approval, which is the responsibility of the equipment manufacturer.
- Our liability is only assumed for the Surface Acoustic Wave (SAW) component(s) per se, not for applications, processes and circuits implemented within components or assemblies.
- For questions on technology, prices and delivery, please contact our sales offices or e-mail to sales@vanlong.com.

Package Dimensions (QCC8C)

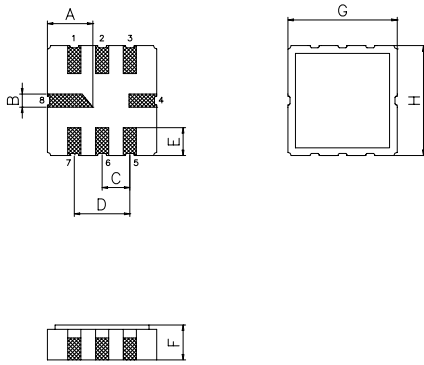

Electrical Connections

Terminals	Connection
2	Terminal 1
6	Terminal 2
4,8	Case-Ground
1,3,5,7	NC

Package Dimensions

Dimensions	Nom (mm)	Dimensions	Nom (mm)
A	2.08	E	1.20
B	0.60	F	1.35
C	1.27	G	5.00
D	2.54	H	5.00

Marking



- R5409 - Part Code
- Frequency in MHz
- Date Code:
 Y : Last digit of year
 WW : Week No.

Equivalent LC Model and Test Circuit



Equivalent LC Model



Test Circuit

Typical Application Circuit

Low Power Transmitter Application



Local Oscillator Application

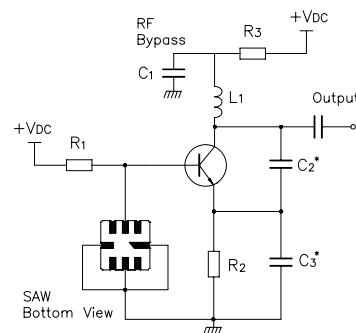

Typical Frequency Response

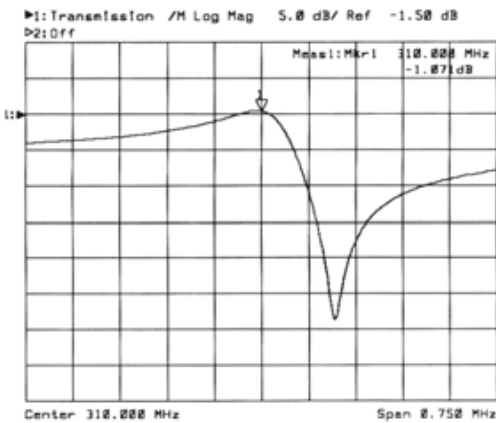

Temperature Characteristics

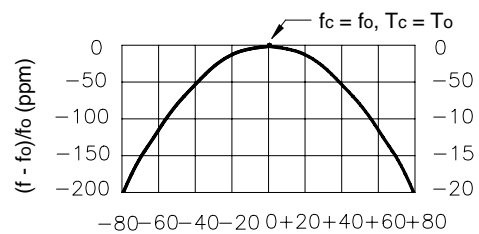

$$\Delta T = T_c - T_o \text{ (}^\circ\text{C)}$$

The curve shown above accounts for resonator contribution only and does not include oscillator temperature characteristics.