

- **Ideal for 980.00 MHz Transmitters**
- **Very Low Insertion Loss**
- **Quartz Stability**
- **Rugged, Hermetic, Low Profile TO-39 Package**

# SR980

Absolute Maximum Rating (Ta=25°C)			
Parameter		Rating	Unit
CW RF Power Dissipation	$P$	0	dBm
DC Voltage	$V_{DC}$	±30	V
Operating Temperature Range	$T_A$	-10 ~ +60	°C
Storage Temperature Range	$T_{stg}$	-40 ~ +85	°C

Electronic Characteristics						
	Parameter	Sym	Minimum	Typical	Maximum	Unit
Frequency (25°C)	Nominal Frequency	$f_C$	NS	980.00	NS	MHz
	Tolerance from 980.00 MHz	$\Delta f_C$	-	-	± 150	KHz
Insertion Loss		$IL$	-	1.3	1.8	dB
Quality Factor	Unloaded Q-Value	$Q_U$	-	11,880	-	-
	50Ω Loaded Q-Value	$Q_L$	-	1,500	-	-
Temperature Stability	Turnover Temperature	$T_O$	25	-	55	°C
	Turnover Frequency	$f_o$	-	$f_c$	-	KHz
	Frequency Temperature Coefficient	$FTC$	-	-0.032	-	ppm/°C <sup>2</sup>
Frequency Aging	Absolute Value during the First Year	$ f_A $	-	-	10	ppm/yr
DC Insulation Resistance Between any Two Pins		-	1.0	-	-	MΩ
RF Equivalent RLC Model	Motional Resistance	$R_M$	-	16.0	23.0	Ω
	Motional Inductance	$L_M$	-	28.2725	-	μH
	Motional Capacitance	$C_M$	-	0.9338	-	fF
	Pin 1 to Pin 2 Static Capacitance	$C_O$	2.05	2.35	2.65	pF

NS = Not Specified

**Notes:**

- The center frequency,  $f_C$ , is measured at the minimum IL point with the resonator in the 50Ω test system.
- Unless noted otherwise, case temperature  $T_C = +25°C \pm 2°C$ .
- Frequency aging is the change in  $f_C$  with time and is specified at +65°C or less. Aging may exceed the specification for prolonged temperatures above +65°C. Typically, aging is greatest the first year after manufacture, decreasing in subsequent years.
- Turnover temperature,  $T_O$ , is the temperature of maximum (or turnover) frequency,  $f_o$ . The nominal frequency at any case temperature,  $T_C$ , may be calculated from:  $f = f_o [1 - FTC (T_O - T_C)^2]$ .
- This equivalent RLC model approximates resonator performance near the resonant frequency and is provided for reference only. The capacitance  $C_O$  is the measured static (nonmotional) capacitance between Pin1 and Pin2. The measurement includes case parasitic capacitance.
- Derived mathematically from one or more of the following directly measured parameters:  $f_C$ ,  $IL$ , 3 dB bandwidth,  $f_C$  versus  $T_C$ , and  $C_O$ .
- The specifications of this device are based on the test circuit shown above and subject to change or obsolescence without notice.
- Typically, equipment utilizing this device requires emissions testing and government approval, which is the responsibility of the equipment manufacturer.
- Our liability is only assumed for the Surface Acoustic Wave (SAW) component(s) per se, not for applications, processes and circuits implemented within components or assemblies.
- For questions on technology, prices and delivery please contact our sales offices or e-mail to sales@vanlong.com.

# 980.00 MHz One-Port SAW Resonator



## Package Dimensions (TO-39)

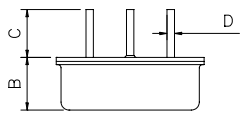

## Electrical Connections

Terminals	Connection
1	Input/ Output
2	Output/ Input
3	Case-Ground

## Package Dimensions

Dimensions	Nom (mm)	
	Min	Max
A	9.10	9.50
B	3.20	3.60
C	2.80	3.20
D	Φ0.25	Φ0.65
E	4.98	5.18
F	2.54 Nominal	
G	0.4	0.5

## Marking



Ink Marking  
Color: Black or Blue

## Equivalent LC Model and Test Circuit

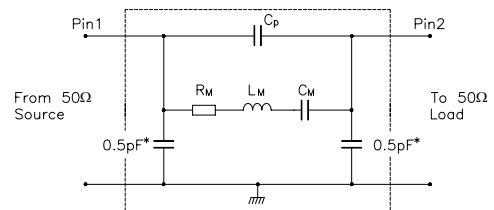

## Typical Application Circuit

### Low Power Transmitter Application

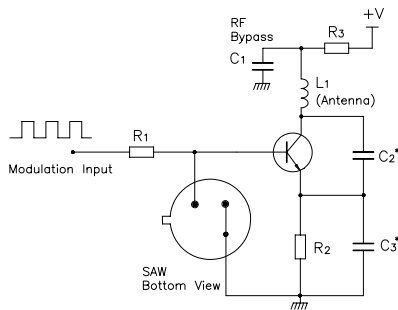

### Local Oscillator Application

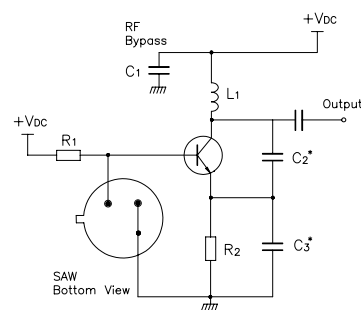

## Typical Frequency Response

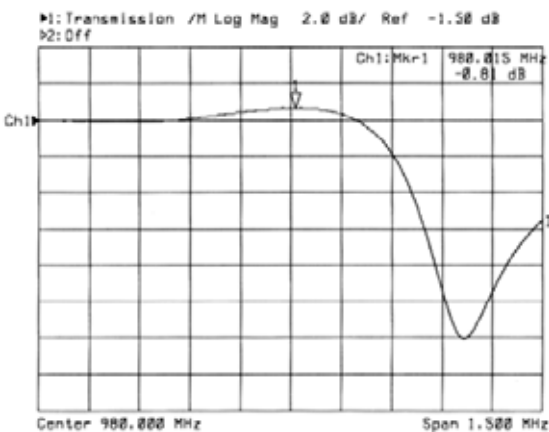

## Temperature Characteristics

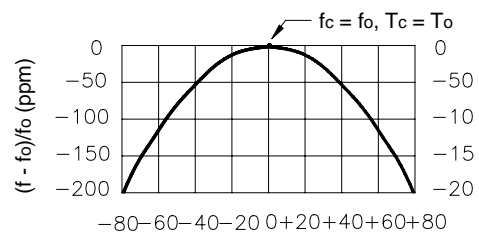

$$\Delta T = T_c - T_o \text{ (}^\circ\text{C)}$$

The curve shown above accounts for resonator contribution only and does not include oscillator temperature characteristics.